



REI

Transportation Electronic Solutions



About REI

Radio Engineering Industries, Inc. (REI) is a leader in designing and manufacturing custom and commercial transportation electronics. For over 70 years, REI has provided products designed to keep you, our customer, in mind. Simply stated, we make quality, value and service our priority.

Located in Omaha, Nebraska, REI infuses state-of-the-art technology into all phases of production, from initial concept and design to shipping of the finished product. REI's extensive experience combined with diversified manufacturing capabilities, creates products that specifically meet the ever changing needs of our customers. REI makes unparalleled service an everyday reality for its customers.

REI's Engineering and Development team ensures quality by expertly designing each product from the ground up using high grade components and manufacturing processes. Our quality design system includes developing and extensively testing our products using the following methods:

- Temperature/Vibration Cycling
- High/Low Operating Temperature
- High/Low Storage Temperature
- High/Low Operating Voltage Test
- DC Voltage Overstress & Reverse Polarity
- Electrostatic Discharge
- Load Dump
- Power Noise Rejection
- Inductive Load Switching
- ISO 9001:2008

REI's products are designed, built and tested to ensure a superior level of performance and durability. REI maintains our commitment to customer satisfaction and continues to make service our primary objective.

REI

Sales: 800.228.9275
402.339.2200

6534 L Street, Omaha, NE 68117
radioeng.com

24 Hour Service: 877.726.4617
Fax: 402.339.1704

Table of Contents

Digital Media Center.....	4	15.4" LCD - Industrial Flip Down.....	20	Wireless Microphones.....	32
Passenger Safety Announcement Player.....	6	15.4" LCD - Motorized.....	20	Handheld.....	32
Mobile Wi-Fi Systems.....	7	19" LCD - Motorized.....	20	Lapel.....	33
Cellular Broadband Router & Mobile Hot Spot.....	7	15.4" LCD - Wall Mount.....	21	Headset.....	33
Camera Observation Systems.....	8	20" LCD - Wall Mount.....	21	Antennas.....	34
Wired Camera Observation System.....	8	22" LCD - Wall Mount.....	21	Flexible AM/FM Universal Mount Antenna.....	34
Wireless Camera Observation System.....	9	9" LCD - Flip Down.....	21	Top/Side Universal Mount Antenna.....	34
Monitors – Wireless.....	10	11.2" LCD - Flip Down.....	21	Flexible AM/FM Universal Mount Antenna.....	34
Monitors – Wired.....	10	15.4" LCD - Flip Down.....	21	Steel Mast Side Mount Antenna.....	34
Cameras - Wireless.....	10	LCD Monitors & Trim Kits.....	22	Steel Mast Telescoping Antenna.....	34
Cameras – Wired.....	10	8" LCD Wedge.....	22	Antenna Extension Cables.....	34
Cables & Accessories.....	10	10.2" LCD Retro Fit Kit.....	22	Silver GM Antenna.....	35
Monitor Specifications.....	11	LCD Monitor Motorcoach Trim Mount Kits.....	22	Ford Econoline Van Antenna.....	35
Camera Specifications.....	11	Video Amplifiers & Video/Power Cables.....	23	Dodge Full-Size Van Antenna.....	35
PA Systems.....	12	Video Distribution Amplifier - RCA...23		AM/FM Amplified Dodge/ Mercedes Sprinter Van Antenna.....	35
1 Channel PA Amplifier.....	12	Video Distribution Amplifier - BNC...23		CB Antenna.....	35
2 Channel PA Amplifier.....	12	RCA Audio/Video Cables.....	23	FM Signal Booster.....	35
2 Channel Transit PA w/Remote Mount Volume Control Panel.....	12	BNC Video Cables.....	23	Speakers.....	36
ECHO PA & Voice Record Dash Module.....	13	Power Cables.....	23	4" Speaker.....	36
Panel Mount PA.....	13	Connectors/Adaptors.....	23	4" Weather Resistant Speakers.....	36
Panel Mount PA Systems.....	13	Video System Control Modules.....	24	4" Coax Square Speaker.....	36
Radios.....	14	Elite System		5" Speaker.....	36
VR-3000 Stereo Radio w/PA.....	14	Elite Control Module.....	24	5" Coax Speaker.....	36
CD-2000 Stereo Radio w/PA.....	14	Elite System Processing Unit.....	24	5.25" Coax Speaker.....	36
ST-4000 Stereo Radio w/PA.....	14	Elite 8 Channel A/V Expansion Module.....	24	5.25" Speaker w/Poly Cone.....	36
ST-3000 Stereo Radio w/PA.....	15	Elite Amplifier.....	24	4" One-Piece Speaker w/Grille.....	37
Pioneer Stereo Radio.....	15	System 2000		6" One-Piece Speaker w/Grille.....	37
Pioneer XM Digital Satellite Tuner Kit.....	15	Digital Control Module.....	25	4" Driver Speaker in ABS Enclosure.....	37
Radios - School.....	16	Amp 3000 Audio Amplifier.....	25	5" Speaker in ABS Enclosure.....	37
CD-2000 Stereo Radio w/PA.....	16	Advanced System		6.5" Speaker w/Grille.....	37
ST-4000 Stereo Radio w/PA.....	16	Advanced System Control Module ..25		6" Speaker w/0.5" Depth Grille.....	37
Custom Harnesses.....	16	Advanced 5 Channel Audio Amplifier.....	25	Speaker w/6.625" Gray Metal Grille.....	37
Panel Mount Radios w/PA - School.....	17	Individual Passenger Seat Back Audio.....	26	6" Speaker w/8" Aluminum Grille.....	37
Panel Mount CD-2000 Stereo Radio w/PA.....	17	Seat Back Audio Module.....	26	8" High Gloss Subwoofer - Passive or Active.....	38
Panel Mount ST-4000 Stereo Radio w/PA.....	17	8 Channel Digital Audio Player.....	26	Dome Tweeter w/Mount Bracket.....	38
Radio Mount Kits/Filters.....	18	30mm Stereo Headphone.....	26	5.25" Speaker w/Bracket.....	38
Radio Mount Kits.....	18	8 Channel Stereo Line Amplifier.....	27	4" Speaker w/Louvered Aluminum Grille.....	38
Universal Radio Housing.....	18	Audio Processor Module.....	27	4" Speaker w/Non-Louvered Aluminum Grille.....	38
10 Amp Filter.....	18	Seat Audio Source Cabinet.....	27	5" PA Horn.....	38
Audio Isolation Transformer w/RCA.....	18	Microphones.....	28	8" PA Horn.....	38
Amplifier - Line Audio Pre-Amp w/RCA.....	18	Dynamic Entertainment Style Microphones.....	28	GPS Navigation System.....	39
Audio/Video Players.....	19	Dynamic Handheld Microphones.....	28	Touch Screen Monitor.....	39
VR-3000 Stereo Radio w/PA.....	19	Carbon Handheld Microphones.....	28	GPS Navigation/Media Player.....	39
DVD Player.....	19	Headphone Microphone System.....	28		
Digital Video Player.....	19	Microphone Cables.....	29		
Driver Controller.....	19	Dynamic Thru-Hole Mount.....	29		
LCD Monitors.....	20	Dynamic Surface Mount.....	29		
15.4" LCD - Wedge.....	20	Carbon Thru-Hole Mount.....	29		
10.1" LCD - Wedge.....	20	Microphone Extension Cables.....	29		
10.2" LCD - Wedge.....	20	Gooseneck Microphones.....	30		
		Vandal Resistant Gooseneck Microphones.....	30		
		Foot Switches & Cables.....	30		
		Gooseneck Microphones.....	31		
		Slimline Mini Gooseneck.....	31		



Digital Media Center

Create a competitive edge in your market by offering your passengers an exciting new entertainment experience. REI's Digital Media Center is the centerpiece of your motorcoach audio/video entertainment system, offering easy access to thousands of movies, songs and photos¹. Provide a fun and relaxing environment for your passengers with programming that's easy and cost effective.

System Includes:

- Digital Media Center with mobile hard drive
- Touchscreen LCD control panel

Features

- Military class mobile computer with 500GB hard drive and vibration dampening system - safe and secure for your mobile environment
- Plays HD and standard definition movies, music and photos
- User-friendly software designed for passenger use
- Safety video priority playback with reporting
- Touch screen LCD control
- Two independent video displays – touch screen display and passenger video output
- USB 3.0 – 10 X faster than USB 2.0 offering quick content downloading²
- Create revenue when the Digital Media Center is leased for entertainment or digital media access
- Password protection from unauthorized use

Licensed Movie Content

REI, in partnership with *Motorcoach Movies*³, is excited to bring the hottest new releases and box-office hits to your fingertips. Movies provide entertainment for all ages and REI's Digital Media Center makes it easy with edited titles and fun creative programming ideas. Choose the movie titles yourself, or leave the choices up to our experienced staff, and we'll put a package together for you... the choice is yours. New movie content will be sent every three (3) months, or on the schedule of your choice.

Available options:

- Studio edited movie titles
- Choice of 25 or 40 movie package
- Over 6,000 titles available⁴
- Content updated every three (3) months
- Two (2) year contract

Audio/Video Entertainment Solutions

Call Your REI
Representative
for Details

As easy as:



Select media type.



Select category.



Select movie.



Select "play now."

Movies

- Provide your customers with a large library of edited movie titles
- HD and standard definition playback for the ultimate movie experience
- Associate movie cover art to the appropriate movie for easy viewer identification
- *Motorcoach Movies* is the perfect movie licensing solution for unlimited movie options

Photos

- Showcase thousands of photos in one convenient location
- Supports digital photos - JPEG, BMP, GIF and TIF
- Slideshow capability with background music

Music

- Store thousands of songs in a convenient, organized system
- Supports digital audio files - MP3, AAC, WMA, OGG and WAV
- Create customized playlists of songs
- Various sort options available - album, artist, song, genre or year
- Conveniently associate album art to music
- Locate your guest's favorite music using the "Search" function

Passenger Safety Announcements

- Display customized audio and video passenger safety messages
- Document the frequency of announcements

1) Motorcoach Movie Fleet license and ASCAP/BMI music license required.

2) Approximate download time is 80 seconds for standard definition movie (3.4G) and 120 sec for HD movie (6.5G).

3) Motorcoach Movies is a division of Swank Motion Pictures Inc, the world's largest non-theatrical distributor of motion pictures for public performance. Swank Motion Pictures is and has been, for over 70 years, the exclusive licensed provider of most Hollywood movies for motion picture rentals and licenses in most markets including motorcoaches, schools, libraries, colleges, hospitals, cruise ships, correctional facilities and more.

4) Buena Vista Pictures, Walt Disney Pictures, Touchtone Films, Hollywood Pictures, Pixar Animated Studios, Miramax Films, Warner Bros., Warner Independent Pictures, Hanna-Barbera, Allied Artists, Lorimar Telepictures, RKO Pictures, Turner Entertainment, Paramount Pictures, Paramount Classics, Republic Pictures, Sony Pictures, Columbia Pictures, TriStar Pictures, Revolution Studios, Screen Gems, DreamWorks Pictures, Go Fish Pictures, Lionsgate, Artisan Films, Universal Pictures, Focus Features, October Films, Polygram, MGM, United Artists, Orion Pictures, Pathe-Cinema, Dimension Films, New Line Cinema, Fine Line Features, First Look Pictures, Picturehouse, IFC Films, ThinkFilms, Dimension Films and HBO.

PASSENGER SAFETY ANNOUNCEMENT PLAYER

MP-1000 Passenger Safety Announcement Player



Safety Video will be Displayed on all Monitors

REI's MP-1000 is an industry innovation in passenger safety announcements. Our affordable digital media player allows you to customize your video and audio safety message and obtain a date and time log to verify your announcement has been played. The REI MP-1000 is equipped with auxiliary video and audio inputs to interface with your existing entertainment system and automatically switches between the two. Playback options include: AutoPlay upon power-up; loop continuous message; or stop/start priority message utilizing a convenient remote play button.

Product Features

- Customizable audio and video message
- Interfaces w/existing entertainment systems
- Auto-play, loop or start-stop playing
- Automatically switches between other video sources
- Playback date/time recorder for verifications
- Driver one-touch playback
- Includes 4GB REI SD card
- Rolling text message capability
- Durable, compact & lightweight



Optional Remote Play Button

Item	Part #
MP-1000 Passenger Safety Announcement Player w/4GB REI SD Card	710273
Optional Remote Play Button	511986
6' Power Cable - Molex Minifit to Bare Wires (other lengths available)	511563
25' RCA Cable - Dual Male to Dual Male (other lengths available)	511653
25' RCA Cable - Single Male to Single Male (other lengths available)	510779
SD Card Reader (1 per order)	690647

MOBILE WI-FI SYSTEMS

Create a Wireless Mobile Hotspot for Customer Convenience

Internet • Music • Games • Email •  • 

REI's mobile broadband routers are specialized for transportation providers, with thousands of users on buses, trains and other vehicles. We know that our customers depend on quick installation and affordability and enjoy the extra bandwidth of multiple cellular links of our multiple connection routers. Whether you're using a laptop, tablet PC, or other handheld device, you'll get reliable Internet access just about anywhere.



Cellular Broadband Router & Mobile Hotspot

- Single or dual 3G/4G factory installed cards
- Rugged enclosure w/secure power connector
- External Wi-Fi and cellular antenna connections
- External power, status and signal strength indicators
- Dual band Wi-Fi hotspot with 3x3 MIMO antenna system
- Automatic load balancing (dual card models only)
- 4 wired Ethernet ports for device connectivity
- Configurable splash page and terms of use display
- Configurable content filtering and per-user bandwidth limiting

Broadband Routers	Part #
Single Mobile Broadband Router Wi-Fi - Sprint	832150
Single Mobile Broadband Router Wi-Fi - Verizon	832152
Single Mobile Broadband Router Wi-Fi - AT&T	Contact REI
Dual Mobile Broadband Router Wi-Fi - 1-Sprint, 1-Verizon	832156
Dual Mobile Broadband Router Wi-Fi - Sprint	832154
Dual Mobile Broadband Router Wi-Fi - Verizon	832155
Dual Mobile Broadband Router Wi-Fi - AT&T	Contact REI
<i>Includes: Modem; Power Cable; and Wi-Fi Antenna</i>	
Cellular Antennas	Part #
Magnetic Mount Low Profile Cellular Antenna (SMA Connector)	210133
Glass Mount Cellular Antenna (SMA Connector)	210134
NMO Mount Cellular Antenna (SMA Connector)	832203
<i>NMO Mount Cellular Antenna Requires 17' Cable</i>	530077

CAMERA OBSERVATION SYSTEMS

REI began designing and manufacturing camera observation systems based on customer demand for a more robust and reliable system. Our current technology includes digital monitors with automatic color correction, advanced on-screen display, auto day/night mode, back lit buttons, automotive rated components and a wide voltage range with protection circuitry. Our waterproof cameras use the latest Sony CCD technology and can see in complete darkness due to high intensity infrared lighting. The cameras also include thermostat controlled heating and high impact housings and mounting hardware. All of our systems are built and tested to withstand constant use in commercial applications and can withstand harsh conditions such as temperature extremes, vibration and power fluctuations.

Monitor Features

- Digital color LCD monitor
- Button backlighting and auto dimming
- View 1, 2, 3 or 4 cameras at the same time*
- Wide operational temperature range
- RCA audio/video AUX input
- 12/24 Volt
- 2.4 GHz (wireless system)

* varies by monitor model

Camera Features

- Sony color CCD image sensor
- Die-cast high impact waterproof housing
- IR illuminated - up to 45' in darkness*
- Built-in thermostat controlled heater**
- Wide operational temperature range
- 12Volt (power provided from monitor)
- DC10.5-28V (wireless camera)
- 2.4 GHz w/100M range (wireless camera)

* Illumination distance varies by camera
(see camera specifications on page 11)
**excluding eyeball cameras

System Accessories

- Metal mounting brackets w/stainless steel hardware
- Insulated camera cable w/watertight connections
- Sunvisor trim ring (monitor)
- Remote control

Wired Camera Observation System



Camera View Options

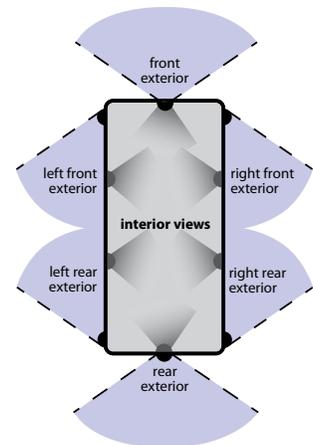

System Description	Monitor View	System - Main Components	Part #
7" LCD w/1 Camera Input, 1 Minibox Camera and 65' Camera Cable	Single Camera View	710346 - 7" Monitor 710311 - Minibox Camera 512369 - 65' Camera Cable	760923
7" LCD w/3 Camera Inputs, 1 Minibox Camera and 65' Camera Cable	Single Camera View	710310 - 7" Monitor 710311 - Minibox Camera 512369 - 65' Camera Cable	760920
7" Quad LCD w/4 Camera Inputs, 1 Minibox Camera and 65' Camera Cable	Monitor Allows for Single/Dual/Quad View	710344 - 7" Monitor 710311 - Minibox Camera 512369 - 65' Camera Cable	760926
5" LCD w/3 Camera Inputs, 1 Minibox Camera and 65' Camera Cable	Single Camera View	710368 - 5" Monitor 710311 - Minibox Camera 512369 - 65' Camera Cable	760921

CAMERA OBSERVATION SYSTEMS

Wireless Camera Observation System



Camera View Options

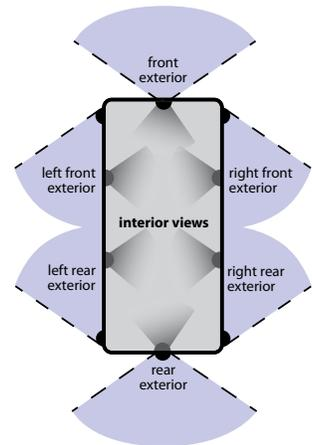

System Description	Monitor View	System - Main Components	Part #
7" Wireless LCD Receives 1 Wireless Camera Image, Includes Wireless Minibox Camera - Channel F	Single Camera View	710401 - Wireless 7" Monitor 710364 - Wireless Minibox Camera - Channel F	760922
7" Wireless Quad LCD Receives up to 4 Wireless Camera Images, Includes 1 Wireless Minibox Camera - Channel F <i>Additional cameras must be ordered separately</i>	Monitor Allows for Single/ Dual/Triple/Quad View	710345 - Wireless 7" Monitor 710364 - Wireless Minibox Camera - Channel F	760927



For additional wireless cameras, see page 10.

CAMERA OBSERVATION SYSTEMS

Monitors - Wireless

		Part #
	7" Wireless LCD Receives 1 Wireless Camera Image	710401
	7" Wireless Quad LCD Receives up to 4 Wireless Camera Images	710345

Monitors - Wired

Item		Part #
	7" LCD w/1 Camera Input, Single Camera View	710346
	7" LCD w/3 Camera Inputs, Single Camera View	710310
	7" Quad LCD w/4 Camera Inputs, Single/Dual/Quad View	710344
	5" LCD w/3 Camera Inputs, Single Camera View	710368

Cameras - Wireless

Item		Part #
	Wireless Camera - Channel F Input on LCD, 2.9mm <i>Required for use with 710401, 7" Wireless LCD with 1 Camera Input. Can be used with 710345 - 7" Wireless Quad Monitor with 4 Camera Inputs</i>	710364
	Wireless Camera - Channel B Input on LCD, 2.9mm <i>Wireless Camera - Only use with WL COS, 7" Quad Monitor with 4 Camera Inputs</i>	710365
	Wireless Camera - Channel R Input on LCD, 2.9mm <i>Wireless Camera - Only use with WL COS, 7" Quad Monitor with 4 Camera Inputs</i>	710366
	Wireless Camera - Channel L Input on LCD 2.9mm <i>Wireless Camera - Only use with WL COS, 7" Quad Monitor with 4 Camera Inputs</i>	710367

Cameras - Wired

Item		Part #
	Minibox Camera w/ Heater, 2.9mm	710311
	Eyeball Camera-Universal Mount, 2.9mm	710342
	Eyeball Camera-Universal Mount, 4mm	710377
	Camera w/Motorized Lens Cover, 2.9mm	710343
	Side Camera - Right side (curb) Forward, Left Side (driver) Backward	710294 (12mm) 710299 (8mm) 710296 (6mm) 710297 (4mm)
	Side Camera - Right side (curb) backward, Left side (driver) forward	710284 (12mm) 710289 (8mm) 710286 (6mm) 710287 (4mm)
	Side Camera, modified for Back-up mounting, 2.8mm	710275

Cables & Accessories

Item		Part #
	Tractor/Trailer Kit, 5' Coiled Cable w/Small 5 Pin Plugs and 2 - 33' Cables w/5 Pin Panel Mount Receptacles	512399
	Tractor/Trailer Kit, 10' Coiled Cable w/Large 7 Pin Plugs and 2 - 33' Cables w/7 Pin Panel Mount Receptacles	512398
	65' Camera Cable	512369
	33' Camera Cable	512401
	15' Camera Cable	512400
	Remote Mount Wireless Antenna w/Cable, 9' Cable	210132
	45' Power Cable, Cigarette Lighter Plug to Bare Wire, 6'	512437
	Power Adaptor, AC Plug to Bare Wire, 4'	512438

CAMERA OBSERVATION SYSTEMS

Monitor Specifications

	Wired 7" Monitor (All Models)	Wired 5" Monitor (All Models)	Wireless 7" Monitor (All Models)
Dimensions (w/o mount)	7.3"W x 4.9"H x .9"D	6"W x 4.6"H x 1.2"D	7.3"W x 4.9"H x .9"D
Screen Ratio	16:10	4:3	16:10
Weight	395g	305g	445g
Operating Voltage	DC 8-28 Volts	DC 8-28 Volts	DC 10.5-28 Volts
Operating Temperature	-15°F to 160°F	-15°F to 160°F	-15°F to 160°F
Display Resolution	2400(3) x 480/800 x 480	1920(3) x 480/640 x 480	2400(3) x 480/800 x 480
Color System	PAL/NTSC (Automatic)		
OSD MENU Function	Brightness, Contrast, Camera Input Plus Separately Set Each Camera: Trigger Priority, Image Switch Delay Time 1-30 Seconds, Mirror/Normal Image Select		
Voltage Input	1.0Vpp-75 OHMS	1.0Vpp-75 OHMS	1.0Vpp-75 OHMS
Brightness	400 cd/m2 (Auto Dimming at Night)		
Contrast Ratio	800:1	800:1	800:1

Camera Specifications

	Minibox Camera	Eyeball Camera	Motorized Camera	Side/Back up Camera	Wireless Camera (2.4GHz)
Image Type	1/3" Sony Color CCD	1/3" Sony Color CCD	1/3" Sony Color CCD	1/3" Sony Color CCD	1/3" Sony Color CCD
Resolution	480TV Lines	480TV Lines	480TV Lines	480TV Lines	480TV Lines
Night Vision Range	0 lux w/infrared lighting, 45'	0 lux w/infrared lighting, 30'	0 lux w/infrared lighting, 45'	0 lux w/infrared lighting, 60'	0 lux w/infrared lighting, 45'
Built-in Heater	Yes	No	Yes	Yes	Yes
Waterproof Rating	IP69K (IP68 + High Pressure Wash and Temperature Resistant)				
Shockproof Rating	100G	100G	100G	100G	100G
Video Output	1.0Vpp-75 OHMS				
Operating Temperature	-15°F to 160°F	-15°F to 160°F	-15°F to 160°F	-15°F to 160°F	-15°F to 160°F
Operating Voltage	DC12V (Regulated Power Provided From Monitor)				
Dimensions (w/o mount)	2.8"W x 1.8"H x 2.3"D	2.9"W x 2.5"H x 2.2"D	3.5"W x 2"H x 2.1"D	2.6"W x 2.5"H x 3.6"D	2.8"W x 1.8"H x 2.3"D
Weight	240g	215g	400g	360g	260g
Current	200mA, 400mA w/Heater On	200mA, 400mA w/Heater On	200mA, 400mA w/Heater On	200mA, 400mA w/Heater On	200mA, 400mA w/Heater On

PA SYSTEMS

1 Channel PA Amplifier



- 2 microphone inputs
- 50 Watt power output
- XLR priority microphone input overrides Minifit Molex secondary microphone input
- Volume control
- AUX audio input
- Approved OEM standard option equipment
- 8”L x 3.125”W x 1.75”H

Item	Part #
1 Channel PA Amplifier	700962
18” Power Cable - 3 Pin Pigtail	511919
24” Speaker Cable - 2 Pin Pigtail	511920
18” AUX Control Cable - 6 Pin Pigtail	511921

2 Channel PA Amplifier



- 2 microphone inputs
- 50 Watt power output
- XLR priority microphone input overrides Minifit Molex secondary microphone input
- Separate internal/external volume control
- AUX audio input w/speaker selectability
- Approved OEM standard option equipment
- 8”L x 3.125”W x 1.75”H

Item	Part #
2 Channel PA Amplifier	700890
18” Power Cable - 3 Pin Pigtail	511919
24” Speaker Cable - 2 Pin Pigtail	511920
18” AUX Control Cable - 6 Pin Pigtail	511921

2 Channel Transit PA w/Remote Mount Volume Control Panel

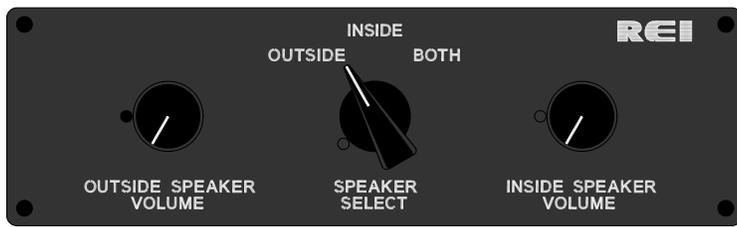

Panel

- 8”L x 2.375”W



- 2 microphone inputs
- Remote panel mounted internal and external volume control
- AUX audio input
- 8”L x 3.125”W x 1.75”H

Item	Part #
2 Channel Transit PA Amplifier	710146
Remote Volume Control Panel	710193
11’ Volume Control Cable	512240
13.5” Main Control Cable	512241
18” AUX Control Cable - 6 Pin Pigtail	512242
24” Speaker Harness	511920

ECHO PA & Voice Record Dash Module



- 4.16”L x 8”W x 1.88”H panel
- 12/24 Volt
- 50 Watt power output
- Single microphone input w/priority control (Minifit Molex connector)
- Internal microphone w/auxilliary microphone input
- Internal and external speaker volume controls
- Approved OEM standard option
- Eliminates unwanted background sounds through active noise cancellation circuit

* Microphone not included

Item	Part #
ECHO PA & Voice Record Dash Module	700854
ECHO PA Module w/o Radio Option	700926

Panel Mount PA



- 2” x 7” panel
- 12 Volt
- 40 Watt power output
- Single channel
- 2 microphone inputs w/priority control

* Microphone not included

Item	Part #
Panel Mount PA	700318

Panel Mount PA System



- 2” x 7” panel
- 12 Volt
- 25 Watt power output
- Single channel
- Volume control

Item	Part #
Panel Mount PA System	700829
Includes: Hand-Held Microphone w/4 Pin Straight CB Style Connector	480024

Panel Mount PA System



- 2.875” x 10.5” panel
- 12 Volt
- 25 Watt power output
- Single channel
- Volume control
- Interior/exterior speaker selection

Item	Part #
Panel Mount PA System	760501
Includes: Hand-Held Microphone w/4 Pin Straight CB Style Connector	480024

Panel Mount PA System



- 4” x 9” panel
- 12 Volt
- 25 Watt power output
- Single channel
- Volume control
- Interior/exterior speaker selection

Item	Part #
Panel Mount PA System	760850
Includes: Hand-Held Microphone w/4 Pin Straight CB Style Connector	480024

Panel Mount PA System



- 3.75” x 12” panel
- 12 Volt
- 25 Watt power output
- Single channel
- Volume control
- Interior/exterior speaker selection

Item	Part #
Panel Mount PA System	760211
Includes: Hand-Held Microphone w/4 Pin Straight CB Style Connector	480024

RADIOS

VR-3000 AM/FM/CD/DVD Stereo Radio w/PA



- AM/FM stereo receiver
- 50 Watt x 4
- Front-panel USB type-A input
- Front-panel SD/SDHC card input
- Plays MP3/WMA/AAC file formats
- Front panel 3.5mm and rear RCA audio input jacks
- 2 dynamic/1 carbon inputs for PA
- Internal PA volume control w/memory
- 10s anti-skip DVD mechanism/30s anti-skip CD
- USA/EURO radio frequency modes
- Station presets stored during power loss



Item	Part #
VR-3000 w/Bare Wires	710248
VR-3000 w/Thor Plug	710302
VR-3000 w/Thomas/Arboc Plug	710326

CD-2000 AM/FM/CD Stereo Radio w/PA



- AM/FM stereo receiver
- 50 Watt x 4
- Front-panel USB type-A input
- Front-panel SD/SDHC card input
- Plays MP3/WMA/AAC file formats
- Front panel 3.5mm and rear RCA audio input jacks
- 2 dynamic/1 carbon inputs for PA
- Internal PA volume control w/memory
- USA/EURO radio frequency modes
- Station presets stored during power loss



Item	Part #
CD-2000 w/o Harness	710358
CD-2000 w/Bare Wires	710293
CD-2000 w/PA & Carbon Mic	710387
CD-2000 w/PA & Dynamic Mic	710389
CD-2000 for System 2000	710340
CD-2000 for Advanced System	710338
CD-2000 for Elite System	710336
CD-2000 w/Thor Plug	710304
CD-2000 w/Thomas/Arboc Plug	710327
CD-2000 w/New Flyer Plug	710359

ST-4000 AM/FM/WB Stereo Radio w/PA



- AM/FM stereo receiver
- 50 Watt x 4
- Front-panel USB type-A input
- Front-panel SD/SDHC card input
- Plays MP3/WMA/AAC file formats
- Front panel 3.5mm and rear RCA audio input jacks
- Weather band w/alert feature
- 2 dynamic/1 carbon inputs for PA
- Internal PA volume control w/memory
- USA/EURO radio frequency modes
- Station presets stored during power loss



Item	Part #
ST-4000 w/Bare Wires	710324
ST-4000 w/Dynamic HH Mic (480015) and 3' Mic Cable (512159)	760924
ST-4000 w/Thor Plug	710313
ST-4000 w/Thomas/Arboc Plug	710328

ST-3000 AM/FM/WB Stereo Radio w/PA



MP3 WB

Item	Part #
ST-3000 w/Bare Wires	710374

- AM/FM stereo receiver
- 50 Watt x 4
- USA/EURO radio frequency modes
- Carbon mic input for PA
- Internal PA volume control w/ memory
- Weather band
- Front panel 3.5mm and rear RCA audio input jacks
- 30 day battery back-up
- Station presets stored during power loss

Pioneer AM/FM/CD/HD Stereo Radio

Satellite Radio Ready

MP3 WMA USB AAC



Item	Part #
Pioneer for System 2000	710279
Pioneer for Advanced System	710282
Pioneer for Elite System	710283

- AM/FM stereo receiver
- 50 Watt x 4
- Built-in HD radio tuner
- Satellite radio ready (tuner kit sold separately)
- Red LED backlighting
- Front-panel USB type-A input
- Plays MP3/WMA/AAC file formats
- Front panel 3.5mm input jack
- Wireless remote control

Pioneer XM Digital Satellite Tuner Kit

The Pioneer XM Digital Satellite Tuner is designed for Pioneer "SAT Radio Ready" CD receivers. Also features display information such as channel name, channel category, artist/feature name, song/program title or composer.



**140+ channels
of coast-to-coast
satellite radio
programming**

Item	Part #
Pioneer XM Satellite Tuner Kit	690638
Kit Includes:	
Pioneer XM Tuner	710285
Pioneer Magnetic XM Antenna	210126
Pioneer XM Tuner/Radio Cable	512356

RADIOS - SCHOOL

CD-2000 AM/FM/CD Stereo Radio w/PA

COMPACT DISC DIGITAL AUDIO MP3 SD WMA USB AAC



Item	Part #
CD-2000 w/Bare Wires and Carbon Mic (480024)	710387

- AM/FM stereo receiver
- 50 Watt x 4
- Front-panel USB type-A input
- Front-panel SD/SDHC card input
- Plays MP3/WMA/AAC file formats
- Front panel 3.5mm and rear RCA audio input jacks
- 2 dynamic/1 carbon inputs for PA
- Internal PA volume control w/memory
- USA/EURO radio frequency modes
- Station presets stored during power loss

ST-4000 AM/FM/WB Stereo Radio w/PA

MP3 SD WMA USB AAC WB



Item	Part #
ST-4000 w/Bare Wires and Carbon Mic (480024)	760931

- AM/FM stereo receiver
- 50 Watt x 4
- Front-panel USB type-A input
- Front-panel SD/SDHC card input
- Plays MP3/WMA/AAC file formats
- Front panel 3.5mm and rear RCA audio input jacks
- Weather band w/alert feature
- 2 dynamic/1 carbon inputs for PA
- Internal PA volume control w/memory
- USA/EURO radio frequency modes
- Station presets stored during power loss

Custom Harnesses (Additional Harnesses Available)

Item	Part #
CD-2000/ST-4000 to Blue Bird	512466
CD-2000/ST-4000 to Blue Bird w/Int-Ext Switch	512459
CD-2000/ST-4000 to Thomas C2 2006+	512444
CD-2000/ST-4000 to Thomas 1999-2005	512467
CD-2000/ST-4000 to IC w/Interior/Exterior Switch	512456

PANEL MOUNT RADIOS w/PA - SCHOOL

Panel Mount CD-2000 Stereo Radio w/PA



- 2.875" x 10.5" panel
- 12 Volt
- 50 Watt per channel
- Interior/exterior speaker selection

Item	Part #
Panel Mount CD-2000 Radio w/PA and IC Plug	760929
Includes: Hand-Held Microphone w/4 Pin Straight CB Style Connector	480024

Panel Mount CD-2000 Stereo Radio w/PA



- 4" x 9" panel
- 12 Volt
- 50 Watt per channel
- Interior/exterior speaker selection

Item	Part #
Panel Mount CD-2000 Radio w/PA and Blue Bird Plug	760930
Includes: Hand-Held Microphone w/4 Pin Straight CB Style Connector	480024

Panel Mount CD-2000 Stereo Radio w/PA



- 3.75" x 12" panel
- 12 Volt
- 50 Watt per channel
- Interior/exterior speaker selection

Item	Part #
Panel Mount CD-2000 Radio w/PA and Blue Bird Plug	760928
Includes: Hand-Held Microphone w/4 Pin Straight CB Style Connector	480024

Panel Mount ST-4000 Stereo Radio w/PA



- 2.875" x 10.5" panel
- 12 Volt
- 50 Watt per channel
- Interior/exterior speaker selection

Item	Part #
Panel Mount ST-4000 Radio w/PA and IC Plug	760934
Includes: Hand-Held Microphone w/4 Pin Straight CB Style Connector	480024

Panel Mount ST-4000 Stereo Radio w/PA



- 4" x 9" panel
- 12 Volt
- 50 Watt per channel
- Interior/exterior speaker selection

Item	Part #
Panel Mount ST-4000 Radio w/PA and Blue Bird Plug	760933
Includes: Hand-Held Microphone w/4 Pin Straight CB Style Connector	480024

Panel Mount ST-4000 Stereo Radio w/PA



- 3.75" x 12" panel
- 12 Volt
- 50 Watt per channel
- Interior/exterior speaker selection

Item	Part #
Panel Mount ST-4000 Radio w/PA and Blue Bird Plug	760932
Includes: Hand-Held Microphone w/4 Pin Straight CB Style Connector	480024

RADIO MOUNT KITS/FILTERS



Photo for Reference Only

Radio Mount Kits

Vehicle Type	Vehicle Year	Part #
Chevrolet Full Size Van	2008-2011	550917
Chevrolet Full Size Van	2001-2007	550916
Chevrolet Full Size Van	1996-2000	560955
Dodge/Chrysler Full Size Van	1978-2003	560956
Dodge/Chrysler Sprinter Van	2007-2009	560957
Dodge/Chrysler Sprinter Van	2003-2006	560959
Ford Econoline Full Size Van	2009-2011	560947
Ford Econoline Full Size Van	1997-2008	560947
Ford Econoline Full Size Van	1981-1996	560958
GMC Savana Full Size Van	2008-2011	550917
GMC Savana Full Size Van	2003-2007	560960
GMC Savana Full Size Van	2001-2002	550916

Universal Radio Housing



- Din or 2-Shaft

Item	Part #
Universal Radio Housing	550344

10 Amp Filter



Item	Part #
10 Amp Filter	450010

Audio Isolation Transformer w/RCA



Item	Part #
Audio Isolation Transformer w/ RCA	461003

Amplifier - Line Audio Pre-Amp w/RCA



Item	Part #
Amplifier - Line Audio Pre-Amp w/RCA	700913

AUDIO/VIDEO PLAYERS

VR-3000 AM/FM/CD/DVD Stereo Radio w/PA



- AM/FM stereo receiver
- 50 Watt x 4
- Front-panel USB type-A input
- Front-panel SD/SDHC card input
- Plays MP3/WMA/AAC file formats
- Front panel 3.5mm and rear RCA audio input jacks
- 2 dynamic/1 carbon inputs for PA
- Internal PA volume control w/memory
- 10s anti-skip DVD mechanism/30s anti-skip CD
- USA/EURO radio frequency modes
- Station presets stored during power loss

Item	Part #
VR-3000 w/Bare Wires	710248
VR-3000 w/Thor Plug	710302
VR-3000 w/Thomas/Arboc Plug	710326

DVD Player



- 12/24 Volt
- NTSC/PAL compatible
- Blue LCD
- Amber LED backlighting
- Special circuitry increases pre-amp level outputs to 2.8 Volts, the highest in the industry

Item	Part #
DVD Player for System 2000	710087
DVD Player for Advanced System	710088
DVD Player for Elite System	710089

Digital Video Player

Let REI's digital video player become your digital tour guide. Play back customized pre-recorded video narratives for your motorcoach tour groups. Your content can be manually activated by the driver controller or automatically triggered based on GPS coordinates. Plus, offer your tours in different languages to better serve your clientele.



Driver Controller



- Uses compact flash cards for digital audio/video storage
- Audio/video files can be auto-played via GPS coordinates
- Designed to integrate into existing entertainment systems

Item	Part #
Digital Video Player	710262
Driver Controller	710075

LCD MONITORS

15.4" LCD - Wedge



- Widescreen
- 1440x900 resolution
- **LED backlight**
- 160° viewing angle
- 12/24 Volt
- BNC composite video input
- HDMI HD video input
- Remote control

Requires:
Mount Bracket - Part # 560839 or
Part # 560941

Power Cable - See Page 23

Item	Part #
15.4" LCD - Wedge	710024

10.1" LCD - Wedge



- Widescreen
- 1280x800 resolution
- 900:1 contrast
- **LED backlight**
- 400 NIT brightness
- 160° viewing angle
- 12/24 Volt
- RCA composite video input
- HDMI HD video input
- Remote control

Requires:
Mount Bracket - Part # 560968
Power Cable - See Page 23

Item	Part #
10.1" LCD - Wedge	710375

10.2" LCD - Wedge



- Widescreen
- **LED Backlight**
- 350 NIT brightness
- 12/24 Volt
- RCA composite video input
- Remote control

Requires:
Mount Bracket - Part # 560800
Power Cable - See Page 23

Item	Part #
10.2" LCD - Wedge	710225

15.4" LCD - Industrial Flip Down



- Widescreen
- 1440x900 resolution
- **LED backlight**
- 160° viewing angle
- 12/24 Volt
- BNC composite video input
- Remote control

Requires:
Power Cable - See Page 23

Item	Part #
15.4" LCD - Industrial Flip Down	710400

15.4" LCD - Motorized



- Widescreen
- 1440x900 resolution
- **LED backlight**
- 160° viewing angle
- 12/24 Volt
- Motorized mechanism
- BNC composite video input
- Remote control

Requires:
Power Cable - See Page 23

Item	Part #
15.4" LCD - Motorized	710211

19" LCD - Motorized



- Widescreen
- 1440x900 resolution
- 1000:1 contrast
- 400 NIT brightness
- 160° viewing angle
- 12/24 Volt
- Motorized mechanism
- BNC composite video input
- Remote control

Requires:
Power Cable - See Page 23

Item	Part #
19" LCD - Motorized	710213

LCD MONITORS

15.4" LCD - Wall Mount

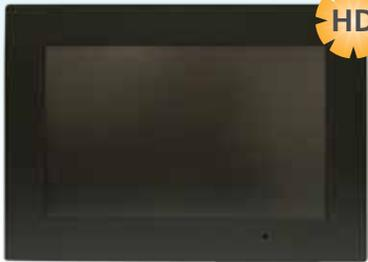

- Widescreen
- 1440x900 resolution
- **LED backlight**
- 160° viewing angle
- 12/24 Volt
- BNC composite video input
- HDMI HD video input
- Remote control

Requires:
Power Cable - See Page 23

Item	Part #
15.4" LCD - Wall Mount	710221

20" LCD - Wall Mount



- Widescreen
- 1600x900 resolution
- 160° viewing angle
- 12/24 Volt
- BNC composite video input
- HDMI HD video input
- Remote control

Requires:
Mount Bracket. Choose From:
Flush Mount Part # 750250
Surface Mount Part # 750251

Power Cable - See Page 23

Item	Part #
20" LCD - Wall Mount	710301

22" LCD - Wall Mount



- Widescreen
- 1680x1050 resolution
- 700:1 contrast
- 160° viewing angle
- 12/24 Volt
- BNC composite video input
- HDMI HD video input
- Remote control

Wall Mount Kit Available. Part # 750226

Requires:
Power Cable - See Page 23

Item	Part #
22" LCD - Wall Mount	710233

9" LCD - Flip Down



- Widescreen
- **LED backlight**
- 12 Volt
- 30° left/right swivel
- RCA composite video input
- Front panel controls

Requires:
Power Cable - See Page 23
Distribution Amplifier w/Gain Control -
Part # 700886

Item	Part #
9" LCD - Flip Down	710319

11.2" LCD - Flip Down



- Widescreen
- **LED backlight**
- 12 Volt
- 30° left/right swivel
- RCA composite video input
- Front panel controls

Requires:
Power Cable - See Page 23
Distribution Amplifier w/Gain Control -
Part # 700886

Item	Part #
11.2" LCD - Flip Down	710318

15.4" LCD - Flip Down



- Widescreen
- 1024x760 resolution
- 12 Volt
- RCA composite video input
- Front panel controls

Requires:
Power Cable - See Page 23
Distribution Amplifier w/Gain Control -
Part # 700886

Item	Part #
15.4" LCD - Flip Down	710317

LCD MONITORS & TRIM KITS

8" LCD - Wedge



- 4:3 ratio screen size
- 12 Volt
- NTSC/PAL compatible
- BNC composite video input
- Remote control

Requires:
Power Cable - See Page 23

Item	Part #
8" LCD - Wedge	700808

Upgrade your
REI CRT monitors
with new LCDs

10.2" LCD Retro Fit Kit



Item	Part #
10.2" LCD Retro Fit Kit	769975
Kit Includes:	
10.2" LCD Monitor	710225
Adaptor	760881
Mount Bracket	560800

LCD Monitor Motorcoach Trim Mount Kits

Item	Part #
MCI E/J Coach	
15.4"/10.2" LCD Wedge Monitor Bracket Kit - Right	750148
15.4"/10.2" LCD Wedge Monitor Bracket Kit - Left	750149
15.4" LCD Wedge Monitor Trim Kit - Right	550795
15.4" LCD Wedge Monitor Trim Kit - Left	550796
10.2" LCD Wedge Monitor Trim Kit - Right	550780
10.2" LCD Wedge Monitor Trim Kit - Left	550781
<i>Each 15.4" wedge monitor trim kit requires 4' of gray "U" channel rubber trim</i>	080106
<i>Each 10.2" wedge monitor trim kit requires 3' of gray "U" channel rubber trim</i>	
MCI D Coach	
15.4"/10.2" LCD Wedge Monitor Bracket Kit - Right	750143
15.4"/10.2" LCD Wedge Monitor Bracket Kit - Left	750144
15.4" LCD Wedge Monitor Trim Kit - Right	550793
15.4" LCD Wedge Monitor Trim Kit - Left	550794
10.2" LCD Wedge Monitor Trim Kit - Right	550778
10.2" LCD Wedge Monitor Trim Kit - Left	550779
<i>Each 15.4" wedge monitor trim kit requires 4' of gray "U" channel rubber trim</i>	080106
<i>Each 10.2" wedge monitor trim kit requires 3' of gray "U" channel rubber trim</i>	
ABC T Series Coaches	
15.4" LCD Wallmount (#710221) Front Bulk Head Trim Kit	750139
Prevost H & XL Coach	
15.4" LCD Wedge Monitor Parcel Rack Trim Kit - Left/Right	750214
Setra Coach	
15.4" LCD Motorized Monitor w/Replacement Roof Mount Trim Kit	769911
Includes:	
15.4" LCD Monitor - Motorized	710211
Metal Mounting Plate - 15.4" LCD Monitor - Motorized	540880
6' Monitor Power - Molex Minifit to Bare Wires	511563
Gray "U" Channel Rubber Trim (5')	080106
Screw 8/32 x 1" (6 pieces)	020177

VIDEO AMPLIFIERS & VIDEO/POWER CABLES

Video Distribution Amplifier - RCA



- 12 Volt
- RCA connectors
- Power cable included
- Independent gain control

Item	Part #
Video Distribution Amplifier - RCA	700886

Video Distribution Amplifier - BNC

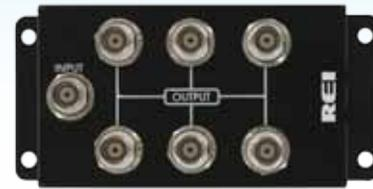

- 12/24 Volt
- BNC connector

Requires: Power Cable - See Below

Item	Part #
Video Distribution Amplifier - BNC	700887

RCA Audio/Video Cables

Item	Part #
------	--------



3' RCA Cable - Dual Male to Male	510564
10' RCA Cable - Dual Male to Male	510572
25' RCA Cable - Dual Male to Male	511653
10' RCA Cable - Single Male to Male	510300
15' RCA Cable - Single Male to Male	510339
25' RCA Cable - Single Male to Male	510779
3' RCA Cable - Single Male to Male	530018
6' RCA Cable - Video & Stereo Audio (3X) Male to Male	512153
10' RCA Cable - Video & Stereo Audio (3X) Male to Male	512086
RCA "Y" Cable - Dual Male to Single Female	510902
RCA "Y" Cable - Single Male to Dual Female	510136
3' RCA Cable - Single Male to Female	511031
6' RCA Cable - Single Male to Female	511398
15' RCA Cable - Single Male to Female	511397

BNC Video Cables

Item	Part #
------	--------



1' BNC Coax Cable - Male to Male	512299
7' BNC Coax Cable - Male to Male	510406
10' BNC Coax Cable - Male to Male	510443
12' BNC Coax Cable - Male to Male	510690
15' BNC Coax Cable - Male to Male	511062
18' BNC Coax Cable - Male to Male	511252
20' BNC Coax Cable - Male to Male	510407
27' BNC Coax Cable - Male to Male	511160
33' BNC Coax Cable - Male to Male	510928
44' BNC Coax Cable - Male to Male	510929

Power Cables

Item	Part #
------	--------

6' Power - Molex Minifit to Bare Wires	511563
15' Power - Molex Minifit to Bare Wires	511858
30' Power - Molex Minifit to Bare Wires	511859
50' Power - Molex Minifit to Bare Wires	511860

Connectors/Adapters

Item	Part #	Item	Part #
------	--------	------	--------

BNC "T" Connector Male to 2 Female (a.)	110195	BNC Female to RCA Male (d.)	110416
BNC Female to BNC Female (b.)	110305	BNC Male to RCA Female (e.)	110468
BNC 75 OHMS Terminator (c.)	110198	RCA Female to RCA Female (f.)	110627

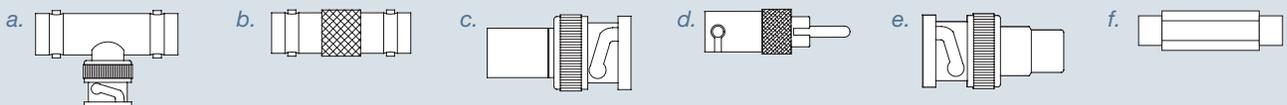

VIDEO SYSTEM CONTROL MODULES

Elite System

REI's newest Elite Series audio/video equipment is designed to bring state-of-the-art mobile multi-media experiences to the transportation industry.

Elite Control Module

The Elite control module has easy-to-use buttons, intuitive menus and a large programmable display. This new intelligent controller gives you up to 9 channels of audio and video at your fingertips - all at the touch of a button.



- 1/2 Din chassis
- 9 channels of audio/video
- Source control including audio/video
- 3 PA inputs w/independent level adjustments
- Separate driver's control section w/built-in amplifier

Elite System Processing Unit

The SPU provides a centralized connection point for plug and play peripherals and includes system status indicators. This is all part of what makes Elite the most advanced system available.



- SPU centralized system controls including:
 - Passenger audio and video sources
 - Integrated power distribution and control
 - Wireless mic integration
 - Expandable for multiple video channels, GPS, and camera options
 - Enhanced audio capabilities, 4.1 audio output

Elite 8 Channel A/V Expansion Module



- Plug and play up to 8 independent audio/video sources
- Audio/video source selection and control provided through Elite control module

Elite Amplifier



- Elite 300 Watt
- 24 Volt
- 150 Watt per channel (peak)
- 2 channel MOSFET bridgeable amplifier
- Industrial grade switch mode power supply
- Full circuit and thermal overload protection
- Input level control
- Power and protection LED indicators

Item	
Elite Control Module	700819
Elite System Processing Unit	700855
Elite 8 Channel A/V Selector	710011
Elite Amplifier	700905

VIDEO SYSTEM CONTROL MODULES

System 2000

The recognized industry standard for over 20 years, the System 2000 continues to provide a full-featured, flexible and reliable audio/video experience.

Digital Control Module



- Complete digital control of audio/video system
- Driver, passenger and public address audio can be individually adjusted for optimum volume, bass and treble levels
- LED display
- Control unit has three public address microphone inputs and the ability to switch between internal and external speakers

Amp 3000 Audio Amplifier



- 300 Watt
- 24 Volt
- 150 Watt per channel (peak)
- 2 channel MOSFET bridgeable amplifier
- Industrial grade switch mode power supply
- Full circuit and thermal overload protection
- Input level control
- Power and protection LED indicators

Item	Part #
Digital Control Module - 24 Volt	700227
Digital Control Module - 12 Volt	700285
Amp 3000, 150 Watt x 2	700771
Amp 3000, Limited Gain - 25 Watt x 2	700799
Amp, 12 Volt - 100 Watt x 2	690143M

750080 adapter cable required if replacing 700511 or 700189 amplifiers w/these models.

Advanced System

Advanced System Control Module



- Din chassis
- 24 Volt
- 2 selectable driver channels w/built-in amplifier
- 3 selectable passenger audio channels
- 3 PA inputs w/independent volume settings
- Source control including audio/video

Advanced 5 Channel Audio Amplifier



- 50 Watt x 4 RMS
- 24 Volt
- Subwoofer output 100 Watt RMS

Item	Part #
Advanced System Control Module	710232
Advanced 5 Channel Audio Amplifier	700537

INDIVIDUAL PASSENGER SEAT BACK AUDIO

REI's individual passenger headphone systems have a rugged, dependable audio control module, free of moving parts. Engineered using the latest technology, they provide clean, high fidelity stereo signals at every seat.

- Up to 8 stereo channel capability
- Digital LED channel display
- Durable soft-touch controls w/wear-resistant overlay
- Individual volume control
- 3.5mm stereo headphone jack
- All electronic switching (no moving parts)
- Headphone amp is overload and short circuit protected
- Compact size: 1/2" recessed depth (1" Overall), 2" height, 5" width
- Components and cables selected for sound quality and reliability

Passengers simply plug in their headphones and choose from a variety of sources: AM/FM CD players, SAT radio, DVD, digital video and digital audio players. All channels feature PA override for driver and tour guide announcements.

Audio Entertainment

The REI passenger headphone system provides the ultimate listening experience. This digital seat-back audio system gives customers the choice of up to eight high-fidelity stereo channels. Each passenger has independent headphone volume control. Whether listening to audio from the REI video system, enjoying an audio book on CD or relaxing to the sounds of digital music, passengers will love the freedom to choose. Customers who prefer to read or sleep while traveling will be able to enjoy the experience without interruptions from the interior speaker systems. Once customers experience the personal entertainment provided by the REI headphone audio system, they will no longer be satisfied with single audio option systems.

Multi-Lingual Tour Capabilities

With the number of foreign tourists increasing, it is a necessity to provide tour announcements and narration in several languages. The combination of the REI passenger headphone system and REI 8 channel digital MP3 audio player is the ultimate way to provide multi-lingual tours. Record tour and stop information in up to eight different languages and provide all of your passengers with the same information. This user-friendly system provides each customer with a choice of language on their seat-back audio module. Upon arriving at each tour stop, the driver initiates the playback of pre-recorded messages in all languages simultaneously.

Seat audio system bill of material depends on type of vehicle, seat configuration and desired features. Contact your REI representative for assistance.

Seat Back Audio Module



- 1-8 channel capability
- Digital LED channel display
- Individual volume control
- Tamper resistant design
- 3.5mm headphone jack
- 0.5" seat mounting depth

Item	Part #
Seat Back Audio Module	700741

8 Channel Digital Audio Player



- 12 Volt
- Plays 8 independent channels of audio simultaneously
- Audio stored on CF-Card
- Great for multilingual audio

Item	Part #
8 Channel Digital Audio Player	710076

30mm Stereo Headphone



- 46" cable w/right angle 3.5mm plug
- Adjustable headband w/rotating earpads
- 32 OHMS impedance

Item	Part #
30mm Stereo Headphone	480282

INDIVIDUAL PASSENGER SEAT BACK AUDIO

8 Channel Stereo Line Amplifier



- Independent audio output level adjustment for up to 8 channels
- LED VU meters for level setting
- Power switch controls power to seat audio units
- 24 Volt DC for low current consumption
- Low harmonic distortion
- PA override capability
- Drive capability of over 100 seat audio units
- Dual output connections for easier installation

Item	Part #
24 Volt 8 Channel Stereo Line Amplifier	700732
12 Volt 8 Channel Stereo Line Amplifier	700710

Audio Processor Module



- Provides channel selection and volume control for 2 seatback audio modules
- Low mounting profile for underseat mounting
- Rugged minifit connector system
- Available in a 5 or 8 channel version
- Integrated headphone amp w/overload and short circuit protection
- Polyswitch fuse protection

Item	Part #
8 Channel Audio Processor	700742
5 Channel Audio Processor	700758

Pre-Recorded Tour Narration

Provide customers the perfect customized tour every time by adding an REI digital audio/video player to the seat-back audio system. Eliminate inconsistent, inaccurate and boring tours. Simply record specific tour information for each point of interest on a compact flash card, install the machine on the bus, make a few wiring connections and the system is ready. A control panel mounted next to the driver is used to operate the system. Upon arriving at each point of interest, the driver simply pushes a button to initiate the narration for that sight. The system is also capable of being automatically triggered based on GPS coordinates eliminating the need for manual control. Multiple buses conducting the same tour simply use copies of the compact flash card and customers get the perfect tour every time. Include advertising messages between tour stops to increase revenue and profits. Eliminate the need for an on-site host or tour guide. Improve passenger perception of the attraction, city or event.

Tour Narration

The REI passenger headphone system is perfect for tour narration. With digital seat-back audio modules supplying crisp, clear stereo signals, customers will hear the tour guide or driver without interruption. Each passenger controls the volume from their headphones independently. No more disturbing road noise or customers complaining they cannot hear. Passengers are sure to have the most enjoyable and memorable tour experience ever. Many companies have expanded their tours to include music entertainment between each tour stop. With REI audio systems, the possibilities are limitless.

Seat Audio Source Cabinet

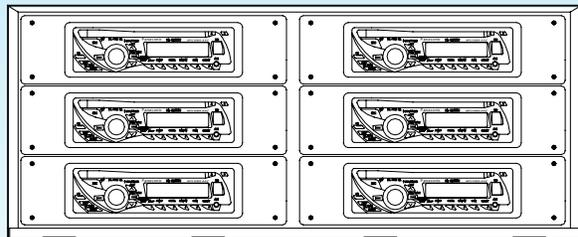

- Modular design
- Holds up to 6 AM/FM/CD radios
- Locking door optional
- Master reset
- Power indicators
- Universal mounting
- Provides conditioned, isolated audio sources to line amplifier
- 24 Volt or 12 Volt versions
- 24"L x 13"W x 10"H

Item	Part #
Seat Audio Source Cabinet	Contact REI

MICROPHONES

Dynamic Microphone Connectors



Pin Out View

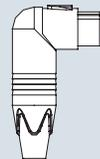

4 Pin 90° Female XLR

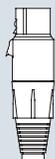

4 Pin Straight Female XLR



4 Pin Straight Male XLR

Carbon Microphone Connectors

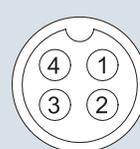

Pin Out View

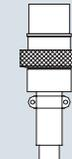

4 Pin CB Style Connector

Dynamic Entertainment Style Microphones

	Part #
Entertainment Microphone w/10' Coiled Cable (#480326 & #511229)	480228
Entertainment Microphone w/10' Straight Cable - 4 Pin 90° Female XLR	480240
Entertainment Microphone w/o Cable	480326
10' Coiled Cable - 4 Pin 90° Female XLR to 4 Pin Straight Female XLR	511229
10' Coiled Cable - 4 Pin Straight Female XLR to 4 Pin Straight Male XLR	511205
10' Coiled Cable - 4 Pin Straight Female XLR to Male Molex (ABC Bus)	511183



Photo for style reference only.

Dynamic Handheld Microphones

	Part #
Handheld Microphone w/3' Coiled Cable - 4 Pin 90° Female XLR	480015
Handheld Microphone w/5' Coiled Cable - 4 Pin 90° Female XLR	480017
Handheld Microphone w/3' Coiled Cable - 4 Pin Straight Female XLR	480080
Handheld Microphone w/3' Coiled Cable - 4 Pin Straight Male XLR (ABC Bus)	480083
Microphone Mounting Clip	480202

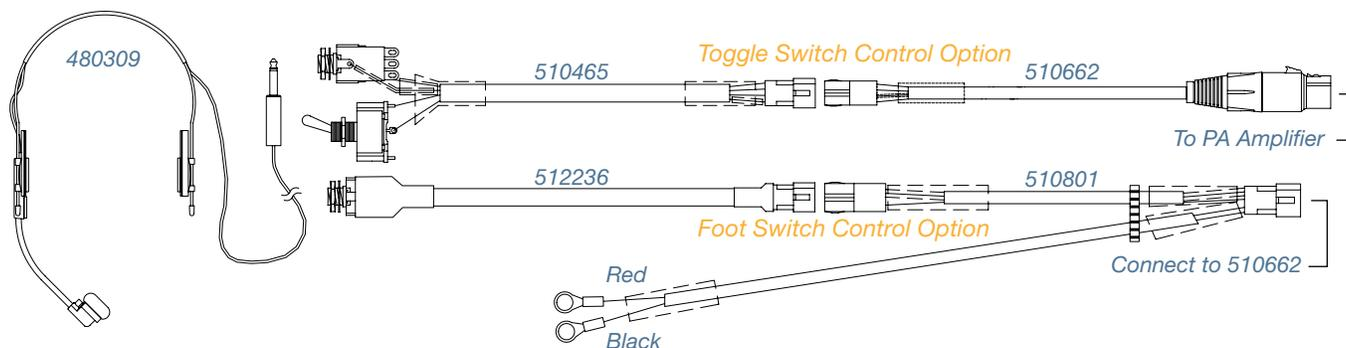

Photo for style reference only.

Carbon Handheld Microphones

	Part #
Handheld Microphone w/3' Coiled Cable - 4 Pin Straight CB Style Connector	480024
Handheld Microphone w/3' Coiled Cable - 5 Pin Straight CB Style Connector	480271

Headphone Microphone System



Toggle Switch Control Option	Part #
Dynamic Headset Microphone	480309
Headphone Microphone Jack w/Switch	510465
7" Dynamic Microphone Cable Extension	510662

Footswitch Control Option	Part #
Dynamic Headset Microphone	480309
Headphone Microphone Jack w/o Switch	512236
7" Dynamic Microphone Cable Extension	510662
15' Footswitch Microphone Cable Harness	510801

MICROPHONE CABLES

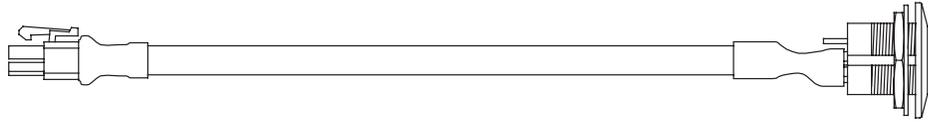

Dynamic Thru-Hole Mount	Part #
1' Cable - Dynamic 4 Pin XLR Microphone Jack to Radio (4 Pin Female Minifit)	512130
3' Cable - Dynamic 4 Pin XLR Microphone Jack to Radio (4 Pin Female Minifit)	512159
6' Cable - Dynamic 4 Pin XLR Microphone Jack to Radio (4 Pin Female Minifit)	512160
10' Cable - Dynamic 4 Pin XLR Microphone Jack to Radio (4 Pin Female Minifit)	512161
17' Cable - Dynamic 4 Pin XLR Microphone Jack to Radio (4 Pin Female Minifit)	512327

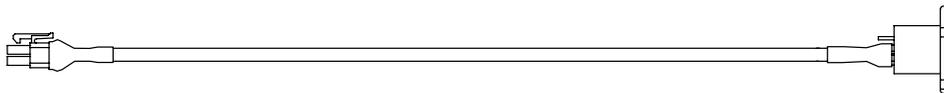

Dynamic Surface Mount	Part #
18" Cable - Dynamic 4 Pin XLR Microphone Jack to Radio (4 Pin Female Minifit)	511178
79" Cable - Dynamic 4 Pin XLR Microphone Jack to Radio (4 Pin Female Minifit)	511412

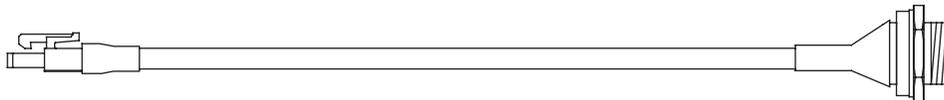

Carbon Thru-Hole Mount	Part #
1' Cable - Carbon 4 Pin CB Style Microphone Jack to Radio (3 Pin Female Minifit)	512341
3' Cable - Carbon 4 Pin CB Style Microphone Jack to Radio (3 Pin Female Minifit)	512365

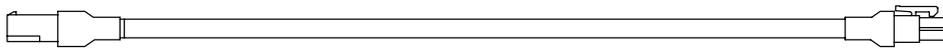

Microphone Extension Cables	Part #
5' Cable - 4 Pin Male Minifit to Radio (4 Pin Female Minifit)	512127
10' Cable - 4 Pin Male Minifit to Radio (4 Pin Female Minifit)	512128
20' Cable - 4 Pin Male Minifit to Radio (4 Pin Female Minifit)	512129
45' Cable - 4 Pin Male Minifit to Radio (4 Pin Female Minifit)	512140

GOOSENECK MICROPHONES

Vandal Resistant Gooseneck Microphones

- REI gooseneck microphones utilize 1.75" mount bases

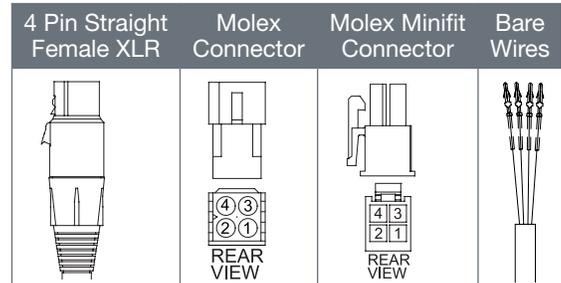
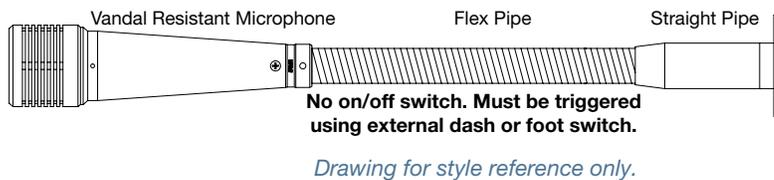

25" VR Microphone w/24" Cable	480304	X		
30" VR Microphone w/24" Cable	480265	X		
30" VR Microphone w/24" Cable	480113BK	X		
33" VR Microphone w/24" Cable	480235	X		
33" VR Microphone w/120" Cable	480303	X		
35" VR Microphone w/24" Cable	480301	X		
36" VR Microphone w/90" Cable	480248	X		
30" VR Microphone w/60" Cable	480206BK		X	
36" VR Microphone w/48" Cable	480239		X	
43" VR Microphone w/18" Straight Pipe, 19" Flex, 31" Cable	480031BK		X	
48" VR Microphone w/4" Straight Pipe, 38" Flex, 26" Cable	480279		X	
30" VR Microphone w/4" Straight Pipe, 20" Flex, 24" Cable	480305			X
33" VR Microphone w/24" Cable	480323			X
25" VR Microphone w/35" Cable	480316			X
30" VR Microphone w/35" Cable	480317			X
33" VR Microphone w/35" Cable	480318			X
36" VR Microphone w/35" Cable	480319			X

Foot Switches & Cables	Part #	
Foot Switch for Use w/Gooseneck Microphone 1" Plunger Style	290042	
Foot Switch for Use w/Gooseneck Microphone Pedal Style	290078	
Plunger Style Foot Switch in Metal Housing	290119	
Cable, 15' for Use w/Foot Switch (Consists of 290042 Foot Switch and 511179 Cable)	510801	
Cable, 7.5' for Use w/Foot Switch	511724	
Cable, 15' for Use w/Foot Switch	511179	

GOOSENECK MICROPHONES

Gooseneck Microphones

- REI gooseneck microphones utilize 1.75" mount bases

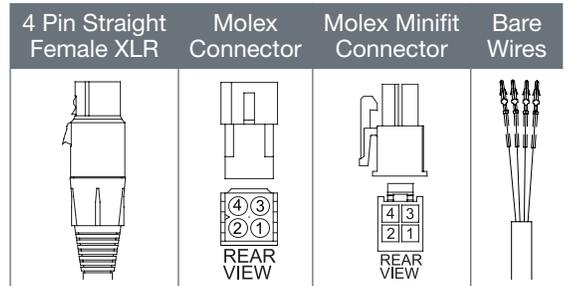
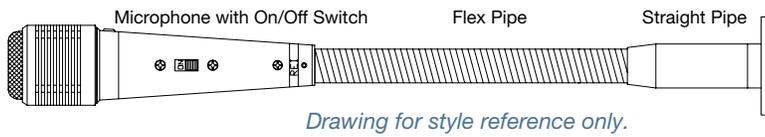

25" Microphone On/Off Switch w/50" Cable	480117BK	X		
30" Microphone On/Off Switch w/70" Cable	480245	X		
30" Microphone On/Off Switch w/125" Cable	480286	X		
30" Microphone On/Off Switch w/24" Cable	480324	X		
33" Microphone On/Off Switch w/43" Cable	480246	X		
36" Microphone On/Off Switch w/40" Cable	480054BK	X		
25" Microphone On/Off Switch w/51" Cable	480047BK		X	
30" Microphone On/Off Switch w/46" Cable	480062BK		X	
33" Microphone On/Off Switch w/43" Cable	480076BK		X	
36" Microphone On/Off Switch w/40" Cable	480027BK		X	
43" Microphone On/Off Switch w/18" Straight Pipe, 19" Flex, 33" Cable	480039BK		X	
44" Microphone On/Off Switch w/32" Cable	480259		X	
48" Microphone On/Off Switch w/18" Straight Pipe, 24" Flex, 28" Cable	480074BK		X	
25" Microphone On/Off Switch w/24" Cable	480310			X
30" Microphone On/Off Switch w/3" Straight Pipe, 19" Flex, 24" Cable	480299			X
36" Microphone On/Off Switch w/30" Flex, 48" Cable	480250NC			X

Slimline Mini Gooseneck	Part #
Slimline 19" Gooseneck Microphone Package	750248
Kit includes:	
Slimline 19" Gooseneck Microphone w/15' PA Input Cable (Minifit Molex) and 10' Foot Switch Cable	480329
Plunger Style Foot Switch in Metal Housing	290119



WIRELESS MICROPHONES

Handheld



Microphone

- 16 user selectable channels
- Powered by 3 rechargeable nickel metal hydride batteries
- 7 hour normal battery life

Charging Station

- 12/24 Volt
- LED indication of charge status
- Refresh cycle to ensure optimum charge

Receiver

- Dual PLL tuner automatically selects strongest signal
- Radio signal indicator
- Audio level indicator
- 12/24 Volt
- Power on/off switch
- 16 user selectable channels

REI Radio or Transit PA	
Wireless Microphone	700598
Wireless Receiver	700862
Charging Station	700532
Receiver to Radio 20'	511659
Molex to Minifit Cable	511532
Receiver Power Cable	511820
Charger Power Cable	511822

System 2000	
Wireless Microphone Kit	750075
Includes:	
Wireless Microphone	700598
Wireless Receiver	700862
Charging Station	700532
Receiver to C-2000 20'	511659
Receiver Power Cable	511820
Charger Power Cable	511822

Elite System	
Wireless Microphone	700598
Wireless Receiver	700862
Charging Station	700532
Receiver to SPU Audio Cable	511903
Receiver to SPU Power Cable	511905
Charger Power Cable	511822

Gemini/Blaupunkt Retrofit System	
REI Retrofit Wireless Kit	750253
Includes:	
Wireless Microphone	700598
Wireless Receiver	700862
Charging Station	700532
Wireless Charger Power Cable	700822
Receiver to Blaupunkt Cable	511847
Mic Adapter Cable	512407

WIRELESS MICROPHONES

Lapel



Lapel Microphone

- Unidirectional microphone w/metal spring clip
- 4' cable w/4 Pin mini XLR connector

Belt Pack Transmitter

- 16 user selectable channels
- 4 Pin mini XLR receptacle
- On/off switch
- Low battery LED
- Requires 3 AA batteries (not included)

Receiver

- Dual PLL tuner automatically selects strongest signal
- Radio signal indicator
- Audio level indicator
- 12/24 Volt
- Power on/off switch
- 16 user selectable channels

REI Radio or Transit PA	
Lapel Microphone	480320
Belt Pack Transmitter	710166
Wireless Receiver	700862
Receiver to Radio 20'	511659
Molex to Minifit Cable	511532
Receiver Power Cable	511820

System 2000	
Lapel Microphone	480320
Belt Pack Transmitter	710166
Wireless Receiver	700862
Receiver to C-2000 20'	511659
Receiver Power Cable	511820

Elite System	
Lapel Microphone	480320
Belt Pack Transmitter	710166
Wireless Receiver	700862
Receiver to SPU Cable	511903
Receiver to SPU Power Cable	511905

Headset



Headset Microphone

- Unidirectional microphone
- 4' cable w/4 Pin mini XLR connector
- Adjustable headband

Belt Pack Transmitter

- 16 user selectable channels
- 4 Pin mini XLR receptacle
- On/off switch
- Low battery LED
- Requires 3 AA batteries (not included)

Receiver

- Dual PLL tuner automatically selects strongest signal
- Radio signal indicator
- Audio level indicator
- 12/24 Volt
- Power on/off switch
- 16 user selectable channels

REI Radio or Transit PA	
Headset Microphone	480321
Belt Pack Transmitter	710166
Wireless Receiver	700862
Receiver to Radio 20'	511659
Molex to Minifit Cable	511532
Receiver Power Cable	511820

System 2000	
Headset Microphone	480321
Belt Pack Transmitter	710166
Wireless Receiver	700862
Receiver to C-2000 20'	511659
Receiver Power Cable	511820

Elite System	
Headset Microphone	480321
Belt Pack Transmitter	710166
Wireless Receiver	700862
Receiver to SPU Cable	511903
Receiver to SPU Power Cable	511905

Other configurations available. Contact your REI representative for assistance.

ANTENNAS

Flexible AM/FM Universal Mount Antenna



- Flexible, rust proof, wire wound mast w/rubber coating
- Split ball adjustable base w/included 60" antenna cable
- Male Motorola plug

Item	Part #
60" Flexible AM/FM Antenna w/Cable	210066
82" Flexible AM/FM Antenna w/Cable	210056
192" Flexible AM/FM Antenna w/Cable	210123
Replacement Rubber Mast	210067

Flexible AM/FM Universal Mount Antenna



- Flexible, rust-proof, wire wound mast w/rubber coating
- Split ball adjustable base
- 3 hole surface mount
- Male Motorola plug

*Requires: 23' Cable
Part # 530060*

- Heavy duty shielded cable jacket
- Grounding strap
- Male Motorola plug

Item	Part #
Flexible AM/FM Universal Mount Antenna	210081

Steel Mast Telescoping Antenna



- 96" 4 section telescoping steel mast
- Dual mounting points
- Includes 96" antenna cable
- Male Motorola plug

Item	Part #
Steel Mast Telescoping Antenna	210000

Top/Side Universal Mount Antenna

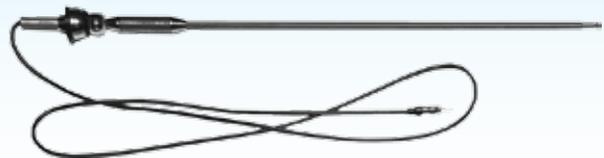

- Single section 31" steel mast
- Universal top or side mount/heavy-duty spring
- Includes 54" antenna cable
- Mast adjustable to 180 degrees
- Male Motorola plug

Item	Part #
Top/Side Universal Mount Antenna	210098

Steel Mast Side Mount Antenna



- Single section 31" steel mast
- Side mount/heavy-duty spring
- Includes 54" detachable antenna cable
- Male Motorola plug

Item	Part #
Steel Mast Side Mount Antenna	210015

Antenna Extension Cables

Motorola Female to Motorola Male Plugs

Item	Part #
24" Extension Cable	530013
36" Extension Cable	530015
48" Extension Cable	530001
96" Extension Cable	530003
144" Extension Cable	530004
240" Extension Cable	530044

ANTENNAS

Silver GM Antenna (1982-Up)



- 31" steel mast
- Universal base w/5 fixed angle pieces
- Includes 72" antenna cable
- Male Motorola plug

Item	Part #
Silver GM Antenna (1982-Up)	210131

Ford Econoline Van Antenna (1979-Up)



- 31" steel mast
- Oval base antenna
- Includes 72" antenna cable
- Male Motorola plug

Item	Part #
Ford Econoline Van Antenna (1979-Up)	210127

Dodge Full-Size Van Antenna (1995-Up)



- 39" 3 section mast
- Side mount base
- Includes 60" detachable antenna cable
- Male Motorola plug

Item	Part #
Dodge Full-Size Van Antenna (1995-Up)	210128

AM/FM Amplified Dodge/Mercedes Sprinter Van Antenna

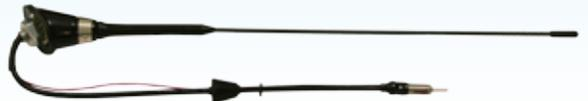

- Includes 15' black removable fiberglass mast
- Includes 6" coax cable and power supply wire
- Male Motorola plug

Item	Part #
AM/FM Amplified Dodge/Mercedes Sprinter Van Antenna	210129

CB Antenna



- 26.965 MHz frequency
- CB band 11 meter channels 1-40
- Single section spring loaded 14" mast
- Oval base
- PL259 connector
- Male Motorola plug

*Requires: 21' Cable
Part # 511132*

- Heavy duty shielded cable jacket
- PL259 connectors
- N connector adaptor
- Male Motorola plug

Item	Part #
CB Antenna	210108

FM Signal Booster



- Amplifies FM signal an average of 8 times
- Improves radio reception
- Extends station range
- 2 Volts maximum total input
- Male Motorola plug

Item	Part #
FM Signal Booster	210103

SPEAKERS

4" Speaker



Grille Part # 240027



Grille Part # 240078



- Full-range speaker
- 30 Watts max power
- 4 OHMS impedance
- 5.4 oz. magnet
- Aluminum voice coil

Item	Part #
4" Speaker	220040

4" Weather Resistant Speaker



Grille Part # 240027



Grille Part # 240078



- 25 Watts max power
- 4 OHMS impedance
- Poly speaker cone
- Solid mylar voice coil cap
- Butyl rubber surround
- 5.4 oz ferrite magnet

Item	Part #
4" Weather Resistant Speaker	220010

4" Weather Resistant Speaker



Grille Part # 240027



Grille Part # 240078



- 25 Watts max power
- 8 OHMS impedance
- Poly speaker cone
- Solid mylar voice coil cap
- Butyl rubber surround
- Includes harness w/2 Pin Weather Pack connector

Item	Part #
4" Weather Resistant Speaker	220089

4" Coax Square Speaker



Grille Part # 240078



- 45 Watts max power
- 4 OHMS impedance
- 2 Pin harness plug
- 1" dome tweeter

Item	Part #
4" Coax Square Speaker	220062
Speaker w/Grille	231003

5" Speaker



Grille Part # 240040



- Full-range speaker
- 30 Watts max power
- 4 OHMS impedance
- 5.4 oz. magnet
- Aluminum voice coil

Item	Part #
5" Speaker	220035

5" Coax Speaker



Grille Part # 240040



- Coax speaker design
- 70 Watts max power
- 10 oz. ferrite magnet
- 1" dome tweeter
- Frequency 80 hz - 20 khz

Item	Part #
5" Coax Speaker	220073

5.25" Coax Speaker



Grille Part # 240032



- 50 Watts max power
- 4 OHMS impedance
- Ferro-fluid cooled voice coil

Item	Part #
5.25" Coax Speaker	220049

5.25" Speaker w/Poly Cone



Grille Part # 240060



- 100 Watts max power
- 4 OHMS impedance
- 10 oz. ferrite magnet
- 1" dome tweeter

Item	Part #
5.25" Speaker w/Poly Cone	220067
Speaker w/Grille	220094

SPEAKERS

4" One-Piece Speaker w/Grille



- Dual cone speaker
- 30 Watts max power
- 4 OHMS impedance
- 5.4 oz magnet

Item	Part #
4" One-Piece Speaker w/Grille	220078
Includes Harness w/2 Pin Molex Minifit Connector	230064

6" One-Piece Speaker w/Grille



- Dual cone speaker
- 30 Watts max power
- 4 OHMS impedance
- 5.4 oz. magnet

Item	Part #
6" One-Piece Speaker w/Grille	220026

4" Driver Speaker in ABS Enclosure



- 4" coax speaker
- 45 Watts max power
- 4 OHMS impedance

Item	Part #
4" Driver Speaker in ABS Enclosure	231009

5" Speaker in ABS Enclosure



- 5.42"W x 5.42"H x 4.3"D
- Coax speaker design
- 70 Watts max power

Item	Part #
5" Speaker w/ 5.4 oz magnet	760663 (Includes 2 Speakers)
5" Speaker w/ 10 oz magnet	760622

6.5" Speaker w/Grille



- 3-way speaker
- 100 Watts max power
- 4 OHMS impedance

Item	Part #
6.5" Speaker w/Grille	220093

6" Speaker w/0.5" Depth Grille



- 25 Watts max power
- 8 OHMS impedance
- Weather resistant

Item	Part #
6" Speaker w/0.5" Depth Grille	230052
Includes: Harness w/2 Pin Weather Pack Plug	230053

Speaker w/6.625" Gray Metal Grille



- 25/30 Watts max power
- 4 OHMS impedance

Item	Part #
4" Speaker	230011
5" Speaker	230002

6" Speaker w/8" Aluminum Grille



- 25 Watts max power
- 8 OHMS impedance
- PVC treated weather resistant speaker cone

Item	Part #
6" Speaker w/8" Aluminum Grille	230061

SPEAKERS

8" High Gloss Subwoofer - Passive or Active



- 150 Watts max power
- Small profile for under seat mounting
- 15.25"L x 8.9"W x 2.7"H

Item	Part #
8" Subwoofer w/Built-in 12/24 Volt Amplifier	230067
8" Subwoofer Speaker - Passive	230066

Dome Tweeter w/Mount Bracket



- 20 Watts max power
- 20 mm tweeter
- 92 dB SPL
- Silk dome tweeter
- Frequency 3 khz - 20 khz

Item	Part #
Dome Tweeter w/Mount Bracket	231007

5.25" Speaker w/Bracket



- 100 Watts max power
- Low profile 1" dome tweeter
- Frequency 55 hz - 22 khz
- Includes harness w/2 Pin Molex minifit connector

Item	Part #
5.25" Speaker w/Bracket	231010

Weather Resistant Exterior Speakers

4" Speaker w/Louvered Aluminum Grille

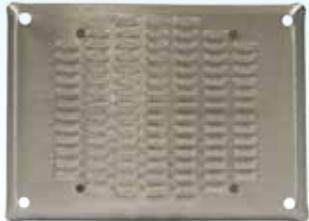

- 6.5" x 4.75" grille
- 25 Watts max power
- 4 OHMS impedance
- Poly woofer cone

Item	Part #
4" Speaker w/Aluminum Grille	230049

4" Speaker w/Non-Louvered Aluminum Grille



- 6.5" x 4.75" grille
- 25 Watts max power
- 8 OHMS impedance
- Poly woofer cone
- Includes harness w/2 Pin Weather Pack connector

Item	Part #
4" Speaker w/Non-Louvered Aluminum Grille	230058

5" PA Horn



- 15 Watts max power
- Aluminum housing
- 8 OHMS impedance
- Adjustable mounting bracket

Item	Part #
5" PA Horn	220022

8" PA Horn



- 30 Watts max power
- 4 OHMS impedance
- Metal housing
- Adjustable mounting bracket

Item	Part #
8" PA Horn	220031PA

GPS NAVIGATION SYSTEM

Touch Screen Monitor



GPS Navigation/Media Player



Item	Part #
Touch Screen Monitor	710356
GPS Navigation/Media Player	710235



Product Features

- Multi-function video/GPS
- Multi-mount for all applications
- Turn signal/reverse activated
- Driver controlled through 7" touch screen LCD
- Viewable on passenger monitors
- Turn by turn audio and visual directions

7" LCD Monitor Mounting Options - Included with System



Pedestal Bracket



U Bracket



In-Dash Bracket



Sales: 800.228.9275
402.339.2200

6534 L Street, Omaha, NE 68117
radioeng.com

24 Hour Service: 877.726.4617
Fax: 402.339.1704